

SCXR SERIES

Commercial Lighting

SCXR-4FT-40W-MCT4-D-BK

MCT MCT: Multi Color Temperature (Selectable)



Selection:



The SCX series offers the best and the most comprehensive selection for linear lighting. The various available lengths and widths allow the creation of the desired shape to elevate the areas aesthetics to a unique and modern look while providing an impressive illumination for the occupants. Ideal for, retail locations, offices, lobbies, conference rooms, reception areas, hallways, educational facilities, hotels, and restaurants. FEATURES: Superior Architectural Look Energy-efficient: Low Wattage Consumption & High Lumen Output Easier Wire Management & Install Variety of Mounting Options Multi Color Temperature (Selectable Switch Inside Fixture) Variety Of Factory Customizations Available

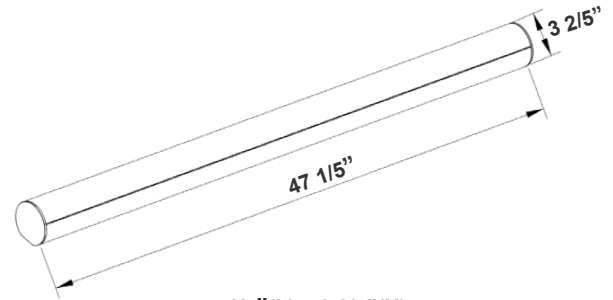

47 1/5"(L) x 3 2/5"(H)

WESTGATE
THE FUTURE IS HERE...AND IT'S QUITE BRIGHT!

Customer Name: _____

Project Name: _____

Note: _____

Type: _____

Features

- LED Superior Architectural Lights
- Seamless Linkable Linear Lighting System
- Opal Polycarbonate Lens-Direct (DOWN) Lighting
- Lens Type: Opal Polycarbonate Lens
- MCT: Multi Color Temperature (Selectable Switch Inside Fixture)

Technical Specifications

Electrical:

- Voltage: 120-277VAC 50/60Hz
- Wattage: 40W
- Power Factor: >0.95
- LWP: 111/ 124/ 116/ 119
- Total Harmonic Distortion: ≤ 20 %

Mechanical:

- Low Profile Modern Design
- Aluminum Housing With Matte Black Finish
- Custom Colors Available
- Lens Snaps into Housing
- Make Different Connections Via L Joints on Both Ends
- Mounting Options: Surface, Suspended, Wall
- IP Rating: IP54
- Operating Temperature: -13°F~104°F

Lighting:

- Dimmable: 0~10V Dimming
- Total Lumens: 4765M/ 5090LM/ 4967LM/ 5052LM
- Color Temperatures: 3000K/3500K/4000K/5000K
- Multi-CCT(Selectable Switch Inside Fixture)
- Color Rendering Index: CRI ≥ 80
- Up Light Option Available
- 50,000 Hours Rated Life
- 5-Year Warranty
- Beam Angle: 104.8°(H) x 100.5°(V)

Applications:

- Ideal for offices, hotels, corridors, saloons, libraries, meeting rooms, conference halls, and the best solution for modern lighting solutions
- It can be used in any indoor applications

Other Models:

- 80W | 10103LM | SCXR-8FT-80W-MCT4-D



Phone: (877) 805-2252 | Fax: (877) 805-2252
www.westgatemfg.com |



WG-Z8-Y7-2Z

Photometrics: SCXR-4FT-40W-MCT4-D-BK

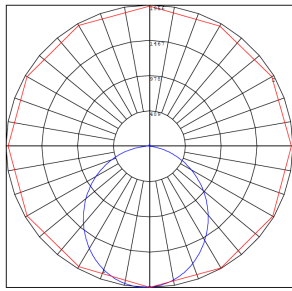
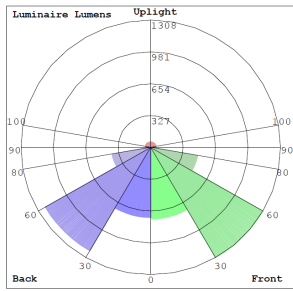

BUD Rating: B2-U3-G2

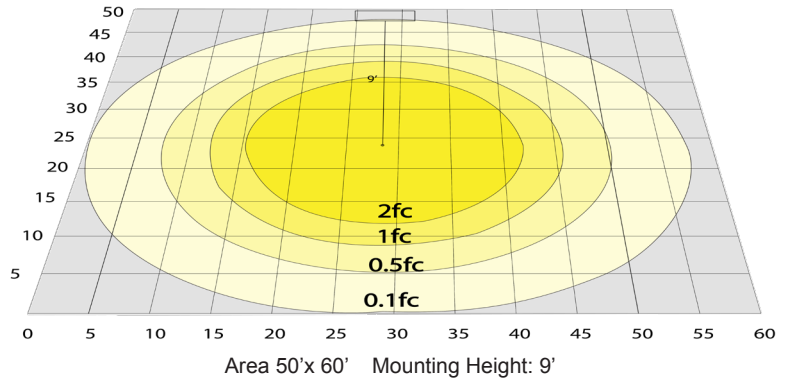

Other Views:



Side View



Front View



Back View

Performance Table: SCXR-4FT-40W-MCT4-D-BK

MODEL NO.	Wattage	Voltage	Lumens	Color Temp.	BUG Rating	LPW
SCXR-4FT-40W-MCT4-D-BK	40W	120~277V	4765LM	3000K	B2-U3-G2	111
			5090LM	3500K		124
			4967LM	4000K		116
			5052LM	5000K		119

Sample Ordering

Model	Size	Wattage	Color Temp.	Dimming	Finish
SCXR	4FT	40W	MCT4	D	BK

Accessories:

Blank = No Option For Accessories

SCL-CS1-6FT = ADJ. 6FT 1/16in SINGLE SUSPENSION CANOPY SET WITH KEYHOLE END CONNECTOR, NON-POWER SIDE

SCL-CS1P-6FT = ADJ. 6FT 1/16in SINGLE SUSPENSION CANOPY SET WITH KEYHOLE END CONNECTOR, POWER SIDE WITH SJTW18/5 WHITE CORD

SCL-CS1P-6FT-NC = ADJ. 6FT 1/16in SINGLE SUSPENSION CANOPY SET WITH KEYHOLE END CONNECTOR

SCL-GS10 = ADJ. 10FT 1/16in DOUBLE SUSPENSION CABLE WITH SINGLE KEYHOLE CONN., LOOP GRIPPER ON TOP

SCL-GS20 = ADJ. 20FT 1/16in DOUBLE SUSPENSION CABLE WITH SINGLE KEYHOLE CONN., LOOP GRIPPER ON TOP

SCL-6FT-SJTW18/5-BK = 6ft Black Cord, SJTW 18 AWG 5-Conductor (Black, White, Green + Purple & Gray for 0-10V Dimming)

SCL-6FT-SJTW18/5-100FT = 100ft Roll of White Cord, SJTW 18 AWG 5-Conductor (Black, White, Green + Purple & Gray for 0-10V Dimming)

SCL-6FT-SJTW18/5-100FT-BK = 100ft Roll of Black Cord, SJTW 18 AWG 5-Conductor (Black, White, Green + Purple & Gray for 0-10V Dimming)

SCL-6FT-SJTW18/6-100FT = 100ft Roll of Black Cord, SJTW 18 AWG 6-Conductor (Black, White, Green + Purple & Gray for 0-10V Dimming + Red for Backup Invertor)

SCL-AH = Heavy-Duty Auxilliary Hook for Up To 1/16" Aircraft Cable

SCL-ASC-500FT = 1/16" 500 ft. Steel Aircraft Cable Suspension

* More Mounting Options Refer to page 2

Factory-Installed Options:

Blank = No Option For Accessories

OPT-HBC-125BS-BK = 10FT, 15A, 125V, 18/3 STR, BLACK

* More Factory-Installed Options Refer to page 3

SUSPENDED MOUNTING ACCESSORIES (NOT INCLUDED)



SCL-CS1-6FT SCL-CS1P-6FT SCL-CS1P-6FT-NC SCL-GS10 SCL-GS20



SCL-6FT-SJTW18/5-100FT SCL-6FT-SJTW18/5-100FT-BK SCL-ASC-500FT SCL-6FT-SJTW18/6-100FT



SCL-AH SCL-ASC-500FT SCL-6FT-SJTW18/5-BK

FACTORY-INSTALLED OPTIONS:



OPT-HBC-125BS-BK



CORNER MODULES (not lighted):



SCXR-LNL
3.25" X 4.25" X 3.93" X 3.38"

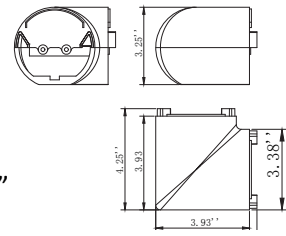

MOUNTING OPTIONS:

LINKING

Model	DESCRIPTION
OPT-SCXR-LINKWIRING	Fixtures are equipped with pre-installed linking brackets and accessories and only need to be wired together. To receive a fixture prewired for linking, order the option below for each link to another fixture or a corner module.

WALL MOUNTING

Model	DESCRIPTION	
OPT-SCX-WMA-4FT	Add this option to the fixture, and wall mounting arms with a wall canopy will be installed on the back of the fixture. The length of each arm is 5". Connection cables will enter the fixture through one of the arms. On your purchase order, specify the position of your wire entry from the wall, and the arm will be installed on the back accordingly.	

WALL MOUNTING

Model	DESCRIPTION	
OPT-SCXR-WM-4FT	Install this optional wall mounting brackets on the back of the fixture. Connection cables will enter the fixture through one of these wall-mounting brackets. On your purchase order, please specify the position of where your wire entry from the wall.	

FACTORY-INSTALLED OPTIONS:

COLOR OF YOUR CHOICE

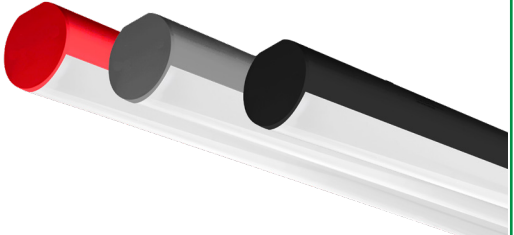
Model	DESCRIPTION	
OPT-SCX-CLR-4FT	Add this option and specify your desired color on your purchase order or provide a swatch to match. For painted flanged fixture or optional rod, mounting set please also add the relevant option below for each fixture.	
OPT-SCX-CLR-FRM	This is a painted flanges option.	
OPT-SCX-CLR-RODSET	This is a painted rod set option.	



INDIRECT (UP) LIGHTING

Model	WATTS	LUMENS	COLOR TEMP	SIZE
OPT-SCX-ULM-4FT-16W-MCT4-BK	16W	1600LM 1648LM 1680LM 1728LM	3000K 4000K 5000K 6000K	4FT
OPT-SCX-ULM-BU	Indirect (up) light with blue color			
OPT-SCX-ULM-GR	Indirect (up) light with green color			



EMERGENCY BATTERY BACKUP

Model	DESCRIPTION
OPT-EM-CM1INT	This is an option for a 90-minute backup battery installation. If you need to order this series for the fixture, please have your purchase order ready and call us or specify on the order which fixture to install this option and the test button.

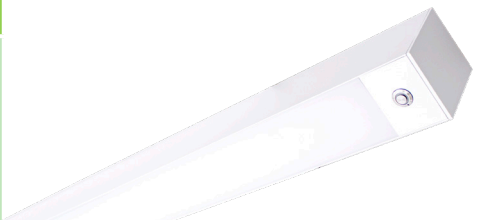

BI-LEVEL MOTION SENSOR

Model	DESCRIPTION
OPT-SEN-SCXR	This option installs an advanced motion sensor that will turn the lights on when the area is occupied. When the area is cleared, after a preset hold time of 5 sec or more the lights are dimmed to a standby level of 30% or more. If still no motion is detected, after the standby period, the light is turned off. All setting is programmable with a remote control.
OPT-WEC-3RC	This is an optional remote control for sensor.

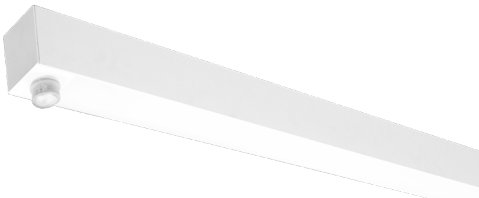

DEDICATED WIRING FOR UPLIGHT CONTROL

Model	DESCRIPTION											
OPT-SCX-ULC-4FT-MCT4-BK	Dedicated Wiring For Uplight Control By Installing A Separate Electrical Circuit And Compatible Driver For Uplighting. This Ensures Independent Control And Power Management. A Driver Regulates The Voltage And Current Supplied To The Uplights, Allowing For Precise Brightness And Color Control, Often Through A Dimmer Or automation System.											
	<table border="1"> <thead> <tr> <th>WATTS</th> <th>LUMENS</th> <th>COLOR TEMP</th> <th>SIZE</th> </tr> </thead> <tbody> <tr> <td rowspan="4">16W</td> <td>1600LM</td> <td rowspan="4">3000K 3500K 4000K 5000K</td> <td rowspan="4">4FT</td> </tr> <tr> <td>1648LM</td> </tr> <tr> <td>1680LM</td> </tr> <tr> <td>1728LM</td> </tr> </tbody> </table>	WATTS	LUMENS	COLOR TEMP	SIZE	16W	1600LM	3000K 3500K 4000K 5000K	4FT	1648LM	1680LM	1728LM
WATTS	LUMENS	COLOR TEMP	SIZE									
16W	1600LM	3000K 3500K 4000K 5000K	4FT									
	1648LM											
	1680LM											
	1728LM											

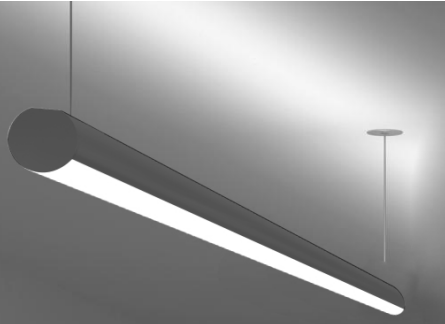

COLOR CHART: * Choose from one of our Premium Colors with no set-up fee.

Gloss:



SILVER METALLIC
70 GLOSS
T357-GR105



SILVER METALLIC
30 GLOSS
T353-GR06



DARK RED 90
GLOSS
P009-RD02



INTERNATIONAL
ORANGE 90
GLOSS
T009-OG26



SAFETY ORANGE
90 GLOSS
T009-OG01



YELLOW 90
GLOSS
T009-YL14



YELLOW 90
GLOSS
T009-YL01

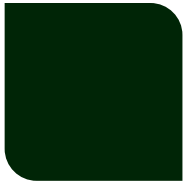

TRAFFIC GREEN
70 GLOSS
T007-GN16



GREEN 70 GLOSS
T007-GN13



GREEN 60 GLOSS
C006-GN03



BLUE 90 GLOSS
T009-BL01



DARK BLUE 80
GLOSS
T008-BL20



RAL 8028 TERRA
BROWN 90 GLOSS
C209-BR358

Hammer:



WHITE HAMMER
T013-WH09



BEIGE HAMMER
T013-BG38



GREY HAMMER
C013-GR08

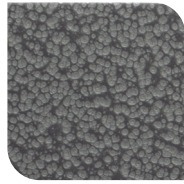

SILVER
HAMMERTONE
T064-GR05



BLACK HAMMER
T013-BK62



RED HAMMER
T013-RD15



GREEN HAMMER
T013-GN220

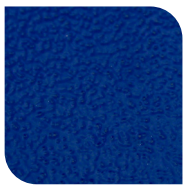

BLUE HAMMER
T013-BL468



BRONZE HAMMER
T012-BR161

Texture:



WHITE TEXTURE
C031-WH120



FLINT GRAY
TEXTURE
T243-GR522



BLACK TEXTURE
C241-BK109



RED TEXTURE
T241-RD129



BLUE TEXTURE
C241-BL544



OIL RUBBED
BRONZE TEXTURE
T291-BR251

Vein:



BLACK/WHITE
VEIN
T075-WH34

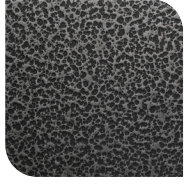

SILVER VEIN
T375-BK26



COPPER VEIN
EXTERIOR
T075-BK211



GOLD VEIN
T375-BK10



COPPER VEIN
T375-BK07

